

GENERAL INFORMATION

Pipes made of borosilicate glass 3.3 in the ball and socket (KF) and flat safety flange systems (PF) have been tried and tested for decades and are particularly well established in the chemical and pharmaceutical industry.

The main reasons for this are that

- Borosilicate glass 3.3 has special qualities, such as transparency, and, when combined with PTFE as a sealing material, it has almost universal chemical stability.
- Pipes made of borosilicate glass 3.3 on the basis of a modular system in accordance with EN 12585 (with basic measurement of 25 mm and many that deviate slightly from this measurement or have slight adaptations), which are standardised in metric units, ensuring structural components can be replaced easily. The result has been numerous improvements to subsequent structural components whilst still maintaining the same level of compatibility.

In addition to the standard component system to be described in the following, client-specific structural components in special lengths and sizes are possible.

- Borosilicate glass 3.3 is an accepted material for the construction of pressure vessels and has been tried and tested over decades – both optimised pipe ends and flange couplings in the ball and socket (KF) and flat safety flange systems are evidence for this. Both flange systems are described in detail in chapter 10 “technical information” (see following figures). They form the basis of the structural components in this catalogue and are also available to purchase as parallel systems. This means clients can continue to use the flange system they have already established or, alternatively, choose the flange system which corresponds to their needs.



All the fundamental facts and information on the construction of pipes and apparatus using borosilicate glass 3.3 are included in chapter 10 “technical information”.

Here you will find details about:

- Properties of borosilicate glass 3.3
- Flange systems and pipe ends in PF and KF systems as well as the corresponding certificates, such as approval by the Technical Guidelines on Air Quality Control (TA-Luft) for the coupling system.
- Approved operating conditions
- Labelling of structural components
- Coating of structural components

- Weight of structural components
- ATEX applications
- GMP applications
- Mounting and assembly of pipes and apparatus
- Safety regulations

In principle the following types of flange are used in PF and KF systems with article numbers ending in F1 to F4.

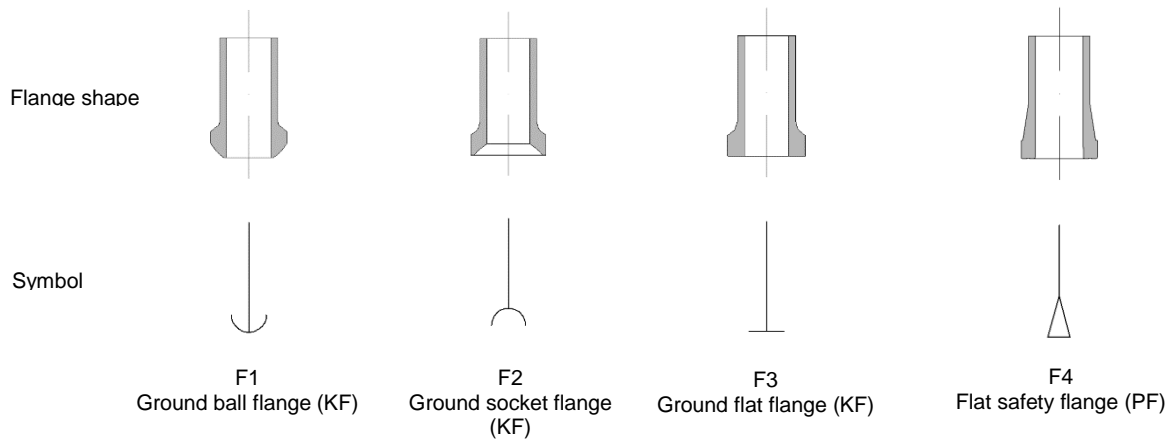

To help identify the ends of flanges the type of flange is entered at the end of each item number, for example “-F44” for pipe sections in the PF system. The order of the flange details is also important in clearly identifying many structural components. The numbering DN 1, DN 2, etc is used for these structural components on the relevant catalogue drawing. Flange types should be entered in the item number according to this order, for example “F121” for the T piece in the example below.

To simplify things, standard items from the flat safety flange system (PF) mentioned in the catalogue are given a label ending in “...P” and from the KF system “...K”.

This catalogue concentrates on structural components in the ball and socket flange system (KF).

Spaces are used for readability, but are not part of the item number.

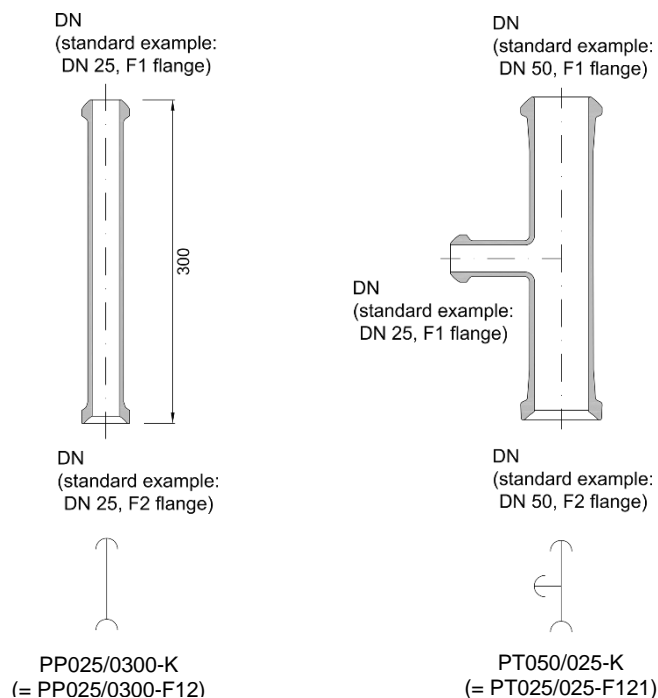

PIPES

In the following table standard pipe parts in accordance with EN 12585 are listed for the nominal diameters of 15 – 600. The flat ball and socket flange system (KF) is manufactured all the way up to a nominal diameter of 600 according to the diagram below. The standard flange combination used up to DN 300 is the ball and socket flange, and in the implementation of plans for nominal diameters of 400 and above the ball and socket flange system is used.



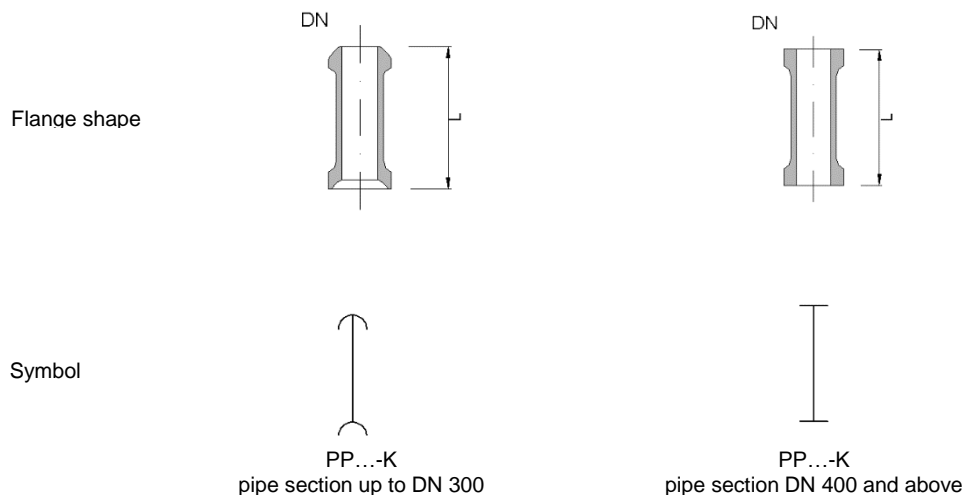

The designs dependent on the nominal diameter are presented in the following figure and the rows of the table are labelled with the corresponding symbols.





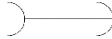

You can find more information on types of pipe end which are dependent on nominal diameter in chap. 10 “technical information” as well as on the corresponding flange couplings and sealing gaskets in chap 2 “couplings”.

We will be happy to deliver all further flange combinations with the KF system and with other flange systems, such as the PF system, or special lengths or options such as coatings. For this you need to add the optional extra digits to the item number as given at the end of the chapter. Several options can be chosen and they are presented as far as possible in alphabetical order. In the following table you will find examples of item numbering for optional extras.

Product name:	Item number	Examples
KF pipe section with special length, for example 265 mm:	PP DN/length-K	PP 100/0265-K
KF pipe section with special flange combination:	PP DN/length-F...	PP 100/0500-F23
Pipe section with flange combination joining KF to PF:	PP DN/length-F14	PP 100/0150-F14
	PP DN/Length-F24	PP 100/0150-F24
Pipe section with coating:	PP DN/length-...-C...	PP 100/0500-K-C3
Pipe section with 2.2 material certificate:	PP DN/length-...-Z2	PP 100/0500-K-Z2
Pipe section with continuous minimal inner diameter:	PP DN/length-...-O1	PP 100/0500-K-O1
Pipe section with calibrated inner diameter:	PP DN/length-...-O2	PP 100/0500-K-O2

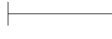
Length [mm]	Item no. DN 15	Item no. DN 25	Item no. DN 40	Item no. DN 50	Item no. DN 80	Item no. DN100
						
75	PP 015/0075-K	PP 025/0075-K	-	-	-	-
100	PP 015/0100-K	PP 025/0100-K	PP 040/0100-K	PP 050/0100-K	-	-
125	PP 015/0125-K	PP 025/0125-K	PP 040/0125-K	PP 050/0125-K	PP 080/0125-K	PP 100/0125-K
150	PP 015/0150-K	PP 025/0150-K	PP 040/0150-K	PP 050/0150-K	PP 080/0150-K	PP 100/0150-K
175	PP 015/0175-K	PP 025/0175-K	PP 040/0175-K	PP 050/0175-K	PP 080/0175-K	PP 100/0175-K
200	PP 015/0200-K	PP 025/0200-K	PP 040/0200-K	PP 050/0200-K	PP 080/0200-K	PP 100/0200-K
250	PP 015/0250-K	PP 025/0250-K	PP 040/0250-K	PP 050/0250-K	PP 080/0250-K	PP 100/0250-K
300	PP 015/0300-K	PP 025/0300-K	PP 040/0300-K	PP 050/0300-K	PP 080/0300-K	PP 100/0300-K
400	PP 015/0400-K	PP 025/0400-K	PP 040/0400-K	PP 050/0400-K	PP 080/0400-K	PP 100/0400-K
500	PP 015/0500-K	PP 025/0500-K	PP 040/0500-K	PP 050/0500-K	PP 080/0500-K	PP 100/0500-K
700	PP 015/0700-K	PP 025/0700-K	PP 040/0700-K	PP 050/0700-K	PP 080/0700-K	PP 100/0700-K
1000	PP 015/1000-K	PP 025/1000-K	PP 040/1000-K	PP 050/1000-K	PP 080/1000-K	PP 100/1000-K
1500	PP 015/1500-K	PP 025/1500-K	PP 040/1500-K	PP 050/1500-K	PP 080/1500-K	PP 100/1500-K
2000	PP 015/2000-K	PP 025/2000-K	PP 040/2000-K	PP 050/2000-K	PP 080/2000-K	PP 100/2000-K
3000	-	PP 025/3000-K	PP 040/3000-K	PP 050/3000-K	PP 080/3000-K	PP 100/3000-K

Length [mm]	Item no. DN 150	Item no. DN 200	Item no. DN 300	Item no. DN 400	Item no. DN 450	Item no. DN600
						
150	PP 150/0150-K	PP 200/0150-K	-	-	-	-
175	PP 150/0175-K	PP 200/0175-K	-	-	-	-
200	PP 150/0200-K	PP 200/0200-K	PP 300/0200-K	-	-	-
250	PP 150/0250-K	-	-	-	-	-
300	PP 150/0300-K	PP 200/0300-K	PP 300/0300-K	-	-	-
400	PP 150/0400-K	PP 200/0400-K	PP 300/0400-K	-	-	-
500	PP 150/0500-K	PP 200/0500-K	PP 300/0500-K	PP 400/0500	PP 450/0500	PP 600/0500
700	PP 150/0700-K	PP 200/0700-K	PP 300/0700-K	-	-	-
1000	PP 150/1000-K	PP 200/1000-K	PP 300/1000-K	PP 400/1000	PP 450/1000	PP 600/1000
1500	PP 150/1500-K	PP 200/1500-K	PP 300/1500-K	PP 400/1500	PP 450/1500	PP 600/1500
2000	PP 150/2000-K	PP 200/2000-K	PP 300/2000-K	PP 400/2000	PP 450/2000	PP 600/2000
3000	PP 150/3000-K	-	-	-	-	-

SPACERS AND ADAPTOR PIECES

Spacers are used to balance out small differences in length and to join different types of flange by clamping the corresponding flange couplings together.

Types of spacer, related symbols and the item numbers for KF couplings or PF to KF couplings are shown in the following diagrams and tables.

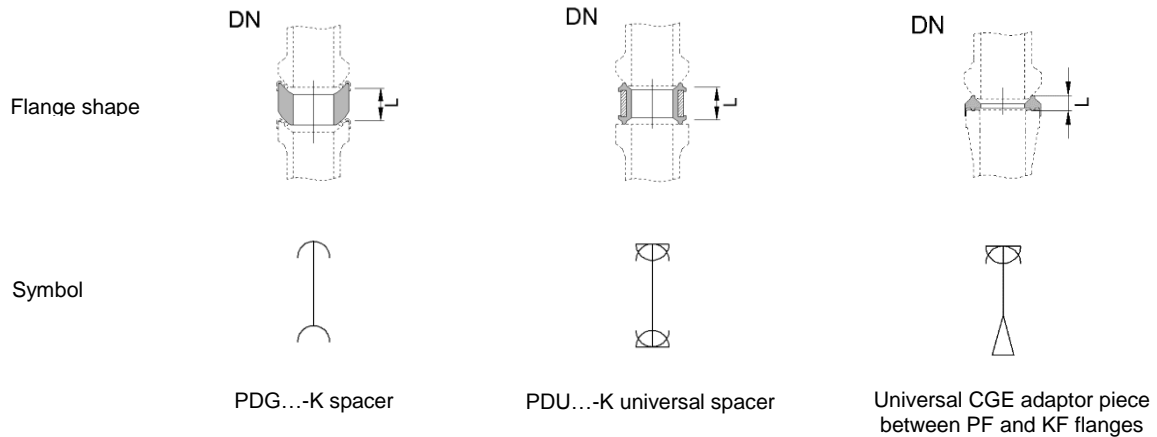

An additional sealing gasket and bolts of a size corresponding to the length of the spacer should be planned in for flange couplings for PDG type glass spacers, which are most frequently used. The additional length in mm is marked by entering option “L” after the item number. Examples of this are shown in the following table. More detailed information on the above-mentioned flange couplings and sealing gaskets can be found in chap. 2 “couplings”.









Alternatively “PDU ...-K” universal spacers made of PTFE with a stainless steel core can be delivered. To make the order the item number “PDG ...-K” should be replaced by “PDU...-K” as shown in the example below.



When using PDU ...-K universal spacers it should be noted that no additional sealing gaskets are necessary and the approved operating conditions are reduced in line with chapter 10 “technical information”.

We will be happy to deliver all further flange combinations and optional extras such as coatings. For this you need to add the optional extra digits to the item number as given at the end of the chapter.

Product name:	Item no.	Examples	Example
		Spacer	Special coupling
Spacer with special length, for example 30 mm	PDG DN/length-K	PDG 100/030-K	CP 100-K-L0030
Spacer with special flange combination:	PDG DN/length-F...	PDG 100/050-F23	CP 100-K-L0050
Glass spacer, joint KF to PF:	PDG DN/length-F14	PDG 100/050-F14	CP 100-PK-L0050
	PDG DN/length-F24	PDG 100/050-F24	CP 100-PK-L0050
Glass spacer with coating:	PDG DN/length-K-C.	PDG 100/050-K-C3	CP 100-K-L0050
Universal KF spacer, PTFE:	PDU DN/length-K	PDU 100/050-K	CP 100-K-L0050
Adaptor piece, PTFE, KF to PF:	CGE DN	CGE 050	CP 050-PK-L0010
Adaptor piece, PTFE, KF to PF, conductive:	CGE DN-M2	CGE 050-M2	CP 050-PK-L0010

TYPE PDG / PDU SPACERS

Length [mm]	Item no. DN 15	Item no. DN 25	Item no. DN 40	Item no. DN 40	Item no. DN 50
					
25	PDG 015/025-K		PDG 025/025-K	PDG 040/025-K	PDG 050/025-K
50	PDG 015/050-K		PDG 025/050-K	PDG 040/050-K	PDG 050/050-K
					
25	PDU 015/025-K		PDU 025/025-K	PDU 040/025-K	PDU 050/025-K
50	PDU 015/050-K		PDU 025/050-K	PDU 040/050-K	PDU 050/050-K

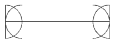
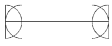
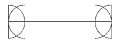
Length [mm]	Item no. DN 80	Item no. DN 100	Item no. DN 150
			
25	-	-	-
50	PDG 080/050-K	PDG 100/050-K	PDG 150/050-K
			
25	-	-	-
50	PDU 080/050-K	PDU 100/050-K	PDU 150/050-K

TYPE CGE ADAPTOR PIECES

“CGE” adaptor pieces are not intended to balance out the length between the PF and KF flange coupling systems but to function as a joint which presents a universal alternative to type “PP .../...-F14” or “PP .../...-F24” und „PP.../...-F34” pipe sections. During assembly the centering collar must be attached to the pipe end containing the flat safety flange. In order to join the structural components a special coupling is needed as shown in the table.

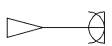
DN	Length [mm]	Item no. Adaptor piece	Special transition coupling (For details see chap. 3 »couplings«)
			
15	6	CGE 015	CP 015-PK-L0005
25	7	CGE 025	CP 025-PK-L0010
40	8	CGE 040	CP 040-PK-L0010
50	8	CGE 050	CP 050-PK-L0010
80	10	CGE 080	CP 080-PK-L0010

REDUCERS

Reducers are available in symmetrical and eccentric designs.



Normally the symmetrical “PR...” shape is used. For specific applications, for example for minimising dead volume in horizontal piping with nominal diameter transition or for more compact designs in vertical piping, “PRE ...” eccentric reducers are used. Eccentric reducers are available in standard up to DN 150. If larger nominal diameters are needed please contact one of our specialist departments.

The measurements for reducers can be seen in the following table.

We will be happy to deliver optional extras such as coatings and further flange combinations for the KF system, for example the “PR ...-31”. flat flange connection is often used for apparatus. For this you need to add the optional extra digits to the item number as given at the end of the chapter.

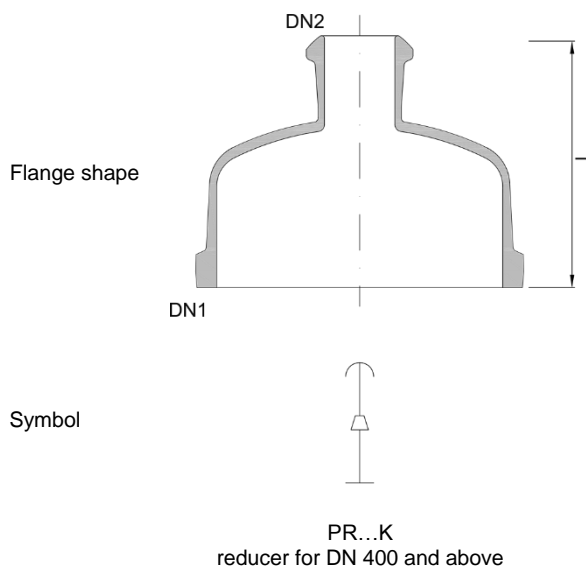
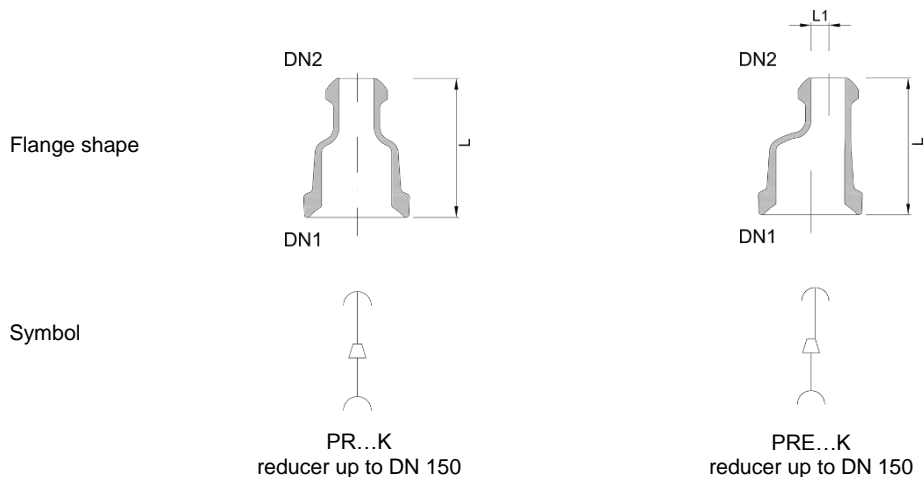
Product name:	Item no.	Example
Symmetrical reducers, KF system:	PR DN1/DN2-K PR DN1/DN2-F31	PR 100/050-K PR 200/050-F31
Eccentric reducers, KF system:	PRE DN1/DN2-K	PRE 100/050-K

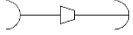

DN1	DN2	L	L1	Item no.	Item no.
-	-	[mm]	[mm]	Symmetrical reducer	Eccentric reducer
					
25	15	100	5	PR 025/015-K	PRE 025/015-K
40	15	100	11	PR 040/015-K	PRE 040/015-K
40	25	100	6	PR 040/025-K	PRE 040/025-K
50	15	100	17	PR 050/015-K	PRE 050/015-K
50	25	100	12	PR 050/025-K	PRE 050/025-K
50	40	100	6	PR 050/040-K	PRE 050/040-K
80	25	125	24	PR 080/025-K	PRE 080/025-K
80	40	125	18	PR 080/040-K	PRE 080/040-K
80	50	125	12	PR 080/050-K	PRE 080/050-K
100	25	150	39	PR 100/025-K	PRE 100/025-K
100	40	150	33	PR 100/040-K	PRE 100/040-K
100	50	150	27	PR 100/050-K	PRE 100/050-K
100	80	150	15	PR 100/080-K	PRE 100/080-K
150	25	200	63	PR 150/025-K	PRE 150/025-K
150	40	200	57	PR 150/040-K	PRE 150/040-K
150	50	200	52	PR 150/050-K	PRE 150/050-K
150	80	200	40	PR 150/080-K	PRE 150/080-K
150	100	200	25	PR 150/100-K	PRE 150/100-K
200	25	175		PR 200/025-K	
200	40	200*		PR 200/040-K	
200	50	200*		PR 200/050-K	
200	80	200		PR 200/080-K	
200	100	200		PR 200/100-K	
200	150	200		PR 200/150-K	
300	25	225		PR 300/025-K	
300	40	225		PR 300/040-K	
300	50	225		PR 300/050-K	
300	80	250		PR 300/080-K	
300	100	250		PR 300/100-K	
300	150	250		PR 300/150-K	
300	200	250		PR 300/200-K	

DN1	DN2	L	L1	Item no.
-	-	[mm]	[mm]	Symmetrical reducer
				
400	25	300		PR 400/025-K
400	40	300		PR 400/040-K
400	50	300		PR 400/050-K
400	80	300		PR 400/080-K
400	100	300		PR 400/100-K
400	150	300		PR 400/150-K
400	200	300		PR 400/200-K
400	300	300		PR 400/300-K
450	25	325		PR 450/025-K
450	40	325		PR 450/040-K
450	50	325		PR 450/050-K
450	80	325		PR 450/080-K
450	100	325		PR 450/100-K
450	150	350		PR 450/150-K
450	200	325		PR 450/200-K
450	300	325		PR 450/300-K
600	50	375		PR 600/050-K
600	80	375		PR 600/080-K
600	100	400		PR 600/100-K
600	150	425		PR 600/150-K
600	200	400		PR 600/200-K
600	300	400		PR 600/300-K

* Lengths which deviate from the previous standard lengths

BENDS

Standard bends are made with 45° and 90° angles and in smaller nominal diameters with a 180° angle (as a U bend). In addition to these standard angles, a range of special angles are offered, in particular 10°, 30° and 80°. For bends with these angles please enter the angle you would like in the item number as shown in the example below.

In addition to these standard bends, space-saving PBR type reducing bends and PBT type bends with temperature connectors are offered as standard variants of 90° bends.

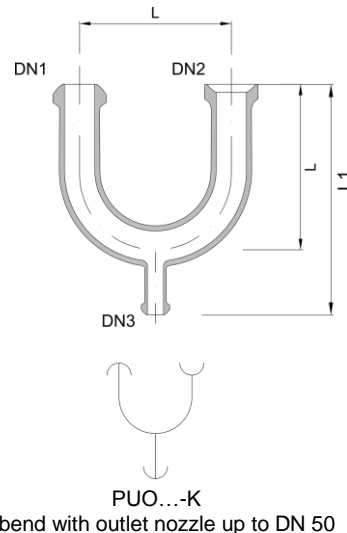
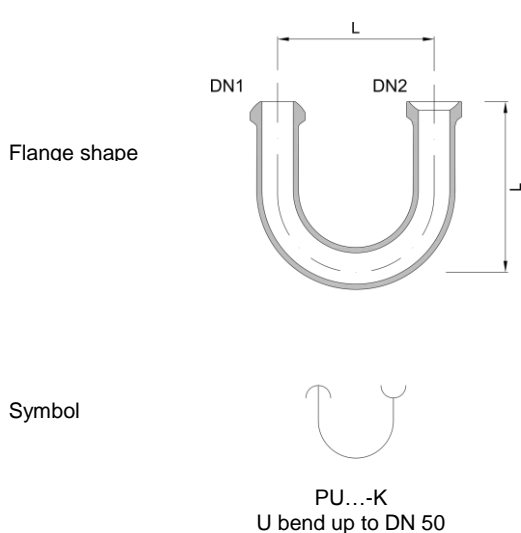
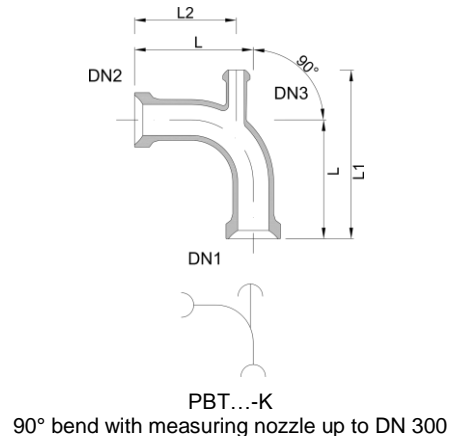
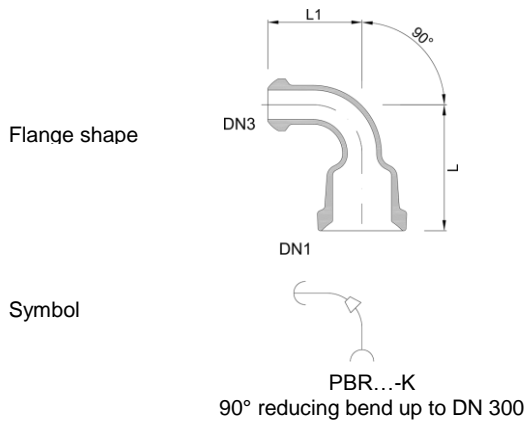
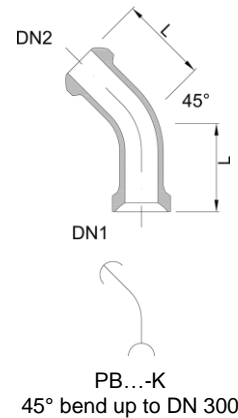
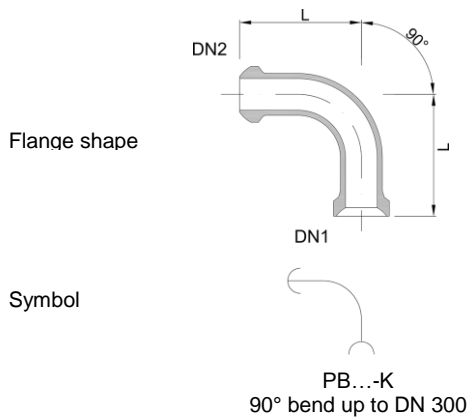

U bends are available in the standard version with an outlet nozzle (PUO type) and without an outlet nozzle (PU type). They are typically used to ventilate pipes or to make liquid seals with a outlet in distillate pipes in columns.





The measurements for bends can be seen in the following table. The item code is:



Product name:	Item no.	Example
90° bend, KF system:	PB 90/DN-K	PB 90/050-K
90° reducing bend, KF system:	PBR DN1/DN2-K	PBR 100/050-K
90° bend with temperature connectors, KF system:	PBT 90/DN-K	PBT 90/100-K
Bend, KF system, elbow design 80°:	PB 80/DN-K	PB 80/050-K
90° bend, KF system, conductive coating:	PB 90/DN-K-C3	PB 90/050-K-C3
U bend, KF system:	PU DN-K	PU 050-K
U bend with outlet, KF system:	PUO DN1/DN3-K	PUO 050/025-K

BENDS 45° / 90°

DN1,2 DN3	L	L1	L2	Item no. 45 ° bend	Item no. 90° bend
-	-	[mm]	[mm]	[mm]	
					
15	50			PB 45/015-K	PB 90/015-K
25	75			PB 45/025-K	
25	100				PB 90/025-K
25	15	100	50	PBR 025/015-K	
40	100			PB 45/040-K	
40	150				PB 90/040-K
40	25	125	100		PBR 040/025-K
50	100			PB 45/050-K	
50	150				PB 90/050-K
50	25	150	100		PBR 050/025-K
50	40	150	150		PBR 050/040-K
50	25	150	250	75	PBT 050/025-K
80	125			PB 45/080-K	
80	200				PB 90/080-K
80	25	150	100		PBR 080/025-K
80	50	150	150		PBR 080/050-K
80	25	200	300	100	PBT 080/025-K
100	175			PB 45/100-K	
100	250				PB 90/100-K
100	25	200	100		PBR 100/025-K
100	50	200	150		PBR 100/050-K
100	80	200	175		PBR 100/080-K
100	25	250	375	100	PBT 100/025-K

DN1,2 DN3	L	L1	L2	Item no.	Item no.
-	-	[mm]	[mm]	45 ° bend	90° bend
					
150	200			PB 45/150-K	
150	250				PB 90/150-K
150	50	200	150		PBR 150/050-K
150	80	250	175		PBR 150/080-K
150	25	250	400	150	PBT 150/025-K
200	200			PB 45/200-K	
200	300				PB 90/200-K
200	50	250	150		PBR 200/050-K
200	80	250	175		PBR 200/080-K
200	25	300	475	150	PBT 200/025-K
300	200			PB 45/300-K	
300	400				PB 90/300-K
300	80	300	175		PBR 300/080-K
300	150	350	250		PBR 300/150-K
300	25	400	625	225	PBT 300/025-K

180° BENDS/ U BENDS

DN1.2 DN3	L	L1	Item no.	Item no.	
-	-	[mm]	U bend	U bend with outlet	
					
15	15	100	200	PU 015-K	PUO 015/015-K
25	25	150	250	PU 025-K	PUO 025/025-K
40	25	150	250	PU 040-K	PUO 040/025-K
50	25	150	250	PU 050-K	PUO 050/025-K

T AND X PIECES

T and X pieces are used to merge and to separate product pipelines.

In order to make them compatible and easy to replace isosceles T and X pieces have the same side length as 90° bends, and angle valves too.

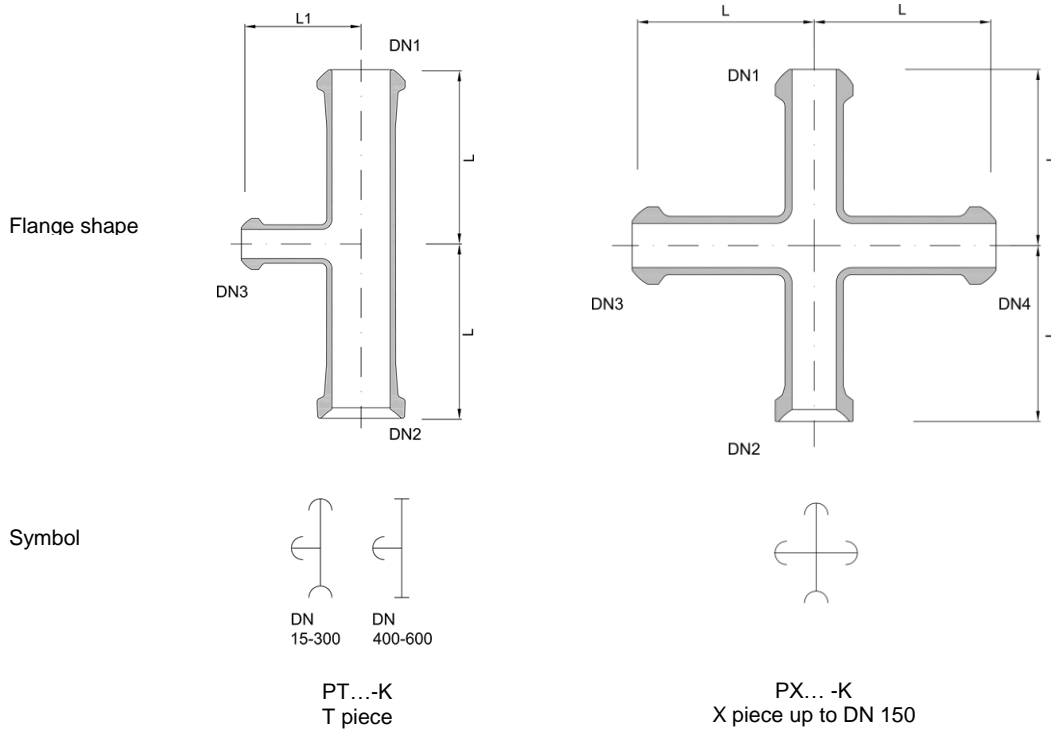

The measurements for standardised T and X pieces can be seen in the following table.

We will be happy to deliver optional extras such as coatings and further flange combinations. For this you need to add the optional extra digits to the item number as given at the end of the chapter. To request specific flange combinations enter the flanges you require in order, DN1, DN2, ..., according to the outline of structural components above.

Product name:	Item no.	Example
T piece, KF system:	PT DN1/DN3-K	PT 050/050-K
T piece with reducing side branch, KF system:	PT DN1/DN3-K	PT 050/025-K
T piece with reducing side branch, special:	PT DN1/DN3-F...	PT 050/025-F231
X piece, KF system:	PX DN1-K	PX 050-K
X piece, special:	PX DN1/DN2/DN3/DN4-F...	PX 050/050/025/025-F2312

DN1.2 DN3.4 L			L1	Item no.	Item no.
-	-	[mm]	[mm]	T piece	X piece
					
15	15	50		PT 015/015-K	PX 015-K
25	15	75	75	PT 025/015-K	
25	25	100		PT 025/025-K	PX 025-K
40	15	100	75	PT 040/015-K	
40	25	100	100	PT 040/025-K	
40	40	150		PT 040/040-K	PX 040-K
50	15	100	75	PT 050/015-K	
50	25	100	100	PT 050/025-K	
50	40	100	100	PT 050/040-K	
50	50	150		PT 050/050-K	PX 050-K
80	25	100	100	PT 080/025-K	
80	40	125	100	PT 080/040-K	
80	50	125	100	PT 080/050-K	
80	80	200		PT 080/080-K	PX 080-K
100	25	100	125	PT 100/025-K	
100	40	125	125	PT 100/040-K	
100	50	125	125	PT 100/050-K	
100	80	150	125	PT 100/080-K	
100	100	250		PT 100/100-K	PX 100-K
150	25	100	150	PT 150/025-K	
150	40	125	150	PT 150/040-K	
150	50	125	150	PT 150/050-K	
150	80	150	150	PT 150/080-K	
150	100	150	150	PT 150/100-K	
150	150	250		PT 150/150-K	PX 150-K

DN1.2 DN3.4 L			L1	Item no.
-	-	[mm]	[mm]	T piece
				
200	25	100	175	PT 200/025-K
200	40	125	175	PT 200/040-K
200	50	125	175	PT 200/050-K
200	80	150	175	PT 200/080-K
200	100	150	175	PT 200/100-K
200	150	200	225	PT 200/150-K
200	200	300		PT 200/200-K
				
300	25	150	225	PT 300/025-K
300	40	200	225	PT 300/040-K
300	50	200	225	PT 300/050-K
300	80	200	225	PT 300/080-K
300	100	200	225	PT 300/100-K
300	150	250	275	PT 300/150-K
300	200	300	275	PT 300/200-K
300	300	400		PT 300/300-K
400	80	200	300	PT 400/080-K
400	150	250	325	PT 400/150-K
450	80	200	325	PT 450/080-K
450	150	250	350	PT 450/150-K
600	80	300	400	PT 600/080-K
600	150	300	425	PT 600/150-K
600	300	400	500	PT 600/300-K

Y PIECES

Y pieces are suitable for merging currents in pipeline construction as well as for assembling parts in vertical pipelines.

The measurements for standardised Y pieces can be seen in the following table.

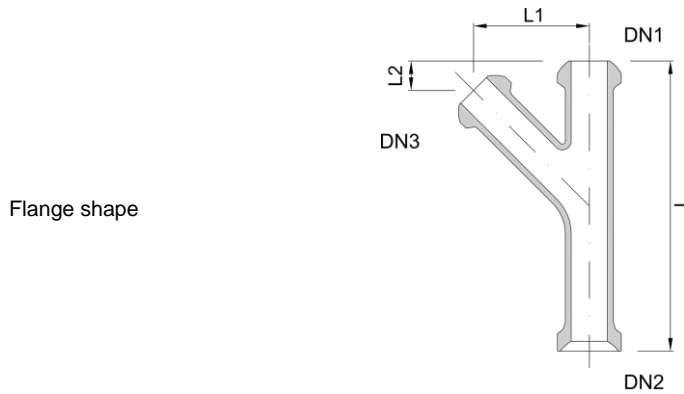

We will be happy to deliver optional extras such as coatings and further flange combinations for the KF system. For this you need to add the optional extra digits to the item number as given at the end of the chapter. To request specific flange combinations enter the flanges you require in order, DN1, DN2, ... , according to the outline above.

Product name:	Item no.	Example
Y piece, KF system:	PY DN1/DN3-K	PY 050/025-K
Y piece, special:	PY DN1/DN3-F...	PY 050/025-F231

DN 1,2	DN3	Length [mm]			Item no. Y piece
		L	L1	L2	



25	25	200	106	19	PY 025/025-K
40	25	225	92	83	PY 040/025-K
50	25	250	97	103	PY 050/025-K
80	25	275	121	79	PY 080/025-K
100	25	325	147	103	PY 100/025-K
150	25	325	197	101	PY 150/025-K

BLIND FLANGES

Blind flanges are normally used to block off pipelines.

The measurements of the blind flanges can be seen in the following table.

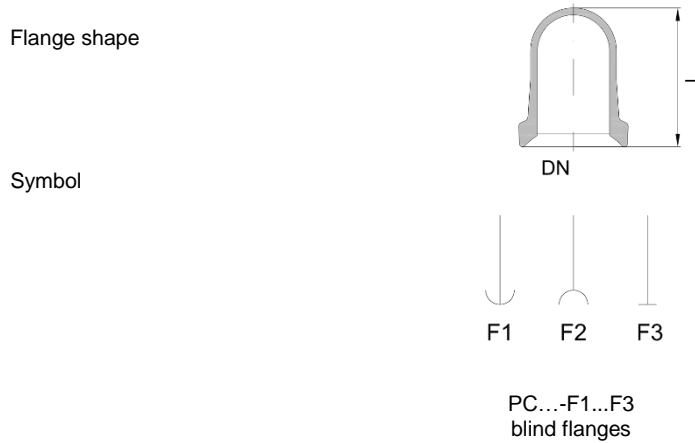

We will be happy to deliver optional extras such as coatings. For this you need to add the optional extra digits to the item number as given at the end of the chapter.

Product name:	Item no.	Example
Blind flange, KF system, ball:	PC DN-F1	PC 050-F1
Blind flange, KF system, socket:	PC DN-F2	PC 050-F2
Blind flange, KF system, flat:	PC DN-F3	PC 050-F3
Blind flange, KF system, ball, conductive coating:	PC DN-F1-C3	PC 050-F1-C3

DN	Length [mm] L	Item no. Blind flange, ball	Item no. Blind flange, socket	Item no. Blind flange, flat
		↓	⌒	⊥
15	40	PC 015-F1	PC 015-F2	PC 015-F3
25	75	PC 025-F1	PC 025-F2	PC 025-F3
40	75	PC 040-F1	PC 040-F2	PC 040-F3
50	100	PC 050-F1	PC 050-F2	PC 050-F3
80	110	PC 080-F1	PC 080-F2	PC 080-F3
100	145	PC 100-F1	PC 100-F2	PC 100-F3
150	125	PC 150-F1	PC 150-F2	PC 150-F3
200	120	PC 200-F1	PC 200-F2	PC 200-F3
300	170	PC 300-F1	PC 300-F2	PC 300-F3

PRODUCT HOSES

Corrosion-proof product hoses are usually used as an alternative to glass piping when product piping needs to be changed regularly or there are very limited amounts of space.

Spiral tubes made of PTFE material with flange adaptors made of borosilicate glass 3.3 (type PHP) are suitable for glass systems. The minimum bending radius for PHP hoses is 35 mm (DN15) or 50 mm (DN25 and DN40). Standard couplings can be used to form pieces with glass piping in accordance with chapter 3.

For applications with higher approved operating pressures and temperatures PTFE-lined hoses with stainless steel braid sleeving (PHE ...) are used as an alternative. They are smooth on the inside. When connecting to glass branches of piping it should be ensured that there is no tension. The recommended connector flange coupling for EN flanges is a CAPE adaptor coupling with a CGS steel core sealing gasket and ring sealing gasket in accordance with chapter 3.

In addition to the standard lengths provided, special lengths can be ordered by entering the option “-L _ _ _ _”.

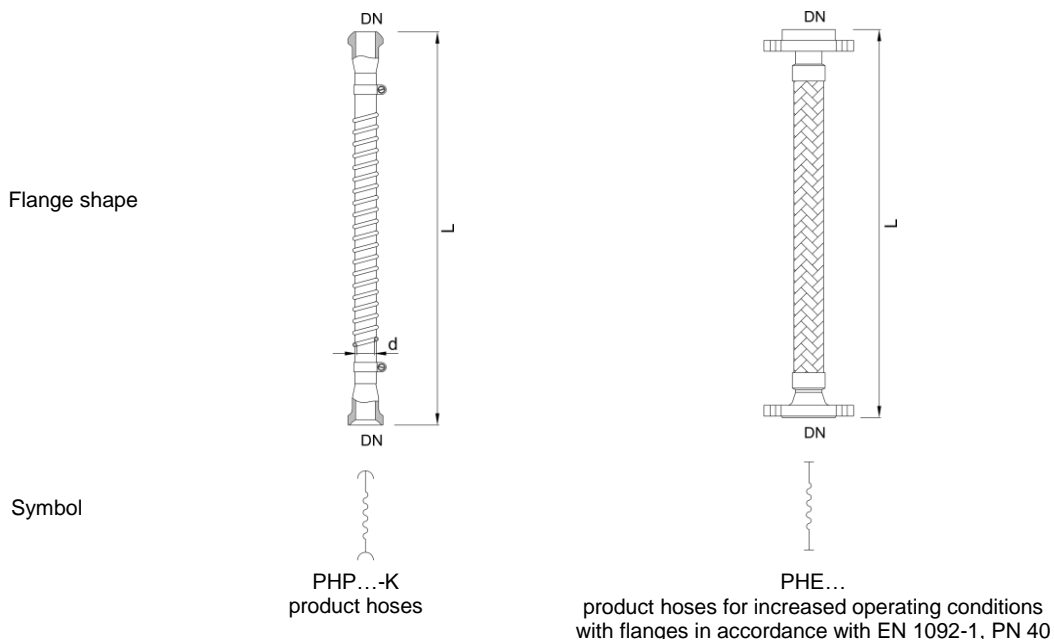

DN	d (PHP)	L	Pressure range	Item no.	Pressure range	Item no.
-	[mm]	[mm]	[at 20 °C]	Product hose	[at 20 °C]	Product hose, sleeved
15	8	500	-1/+4	PHP 15/0500-K		
15	8	1000	-1/+4	PHP 15/1000-K		
15	8	2000	-1/+4	PHP 15/2000-K		
25	17	500	-1/+4	PHP 25/0500-K	-1/+10	PHE 25/0500
25	17	1000	-1/+4	PHP 25/1000-K	-1/+10	PHE 25/1000
25	17	2000	-1/+4	PHP 25/2000-K	-1/+10	PHE 25/2000
40	30	500	-1/+4	PHP 40/0500-K	-1/+10	PHE 40/0500
40	30	1000	-1/+4	PHP 40/1000-K	-1/+10	PHE 40/1000
40	30	2000	-1/+4	PHP 40/2000-K	-1/+10	PHE 40/2000

MEDIA HOSES

Media hoses are connected as flexible piping or connectors for non-corrosive media and most importantly for energy (steam, condensation, heat-transfer media and coolants). The corrugated tubes are lined with a sleeving and connector flanges made of stainless steel. Threaded connectors (e.g. connection to a thermostat) and insulated tube designs can also be delivered optionally. Operational conditions which differ from the standard operating conditions should be included in the order.

The hoses can be delivered in different lengths on request.

A complete coupling made of stainless steel including a sealing gasket for connection to branches of KF type glass piping is included in the delivery. To help with assembly one side contains a loose flange. The bending radius is 50 mm (without insulation) or 80 mm (with insulation).

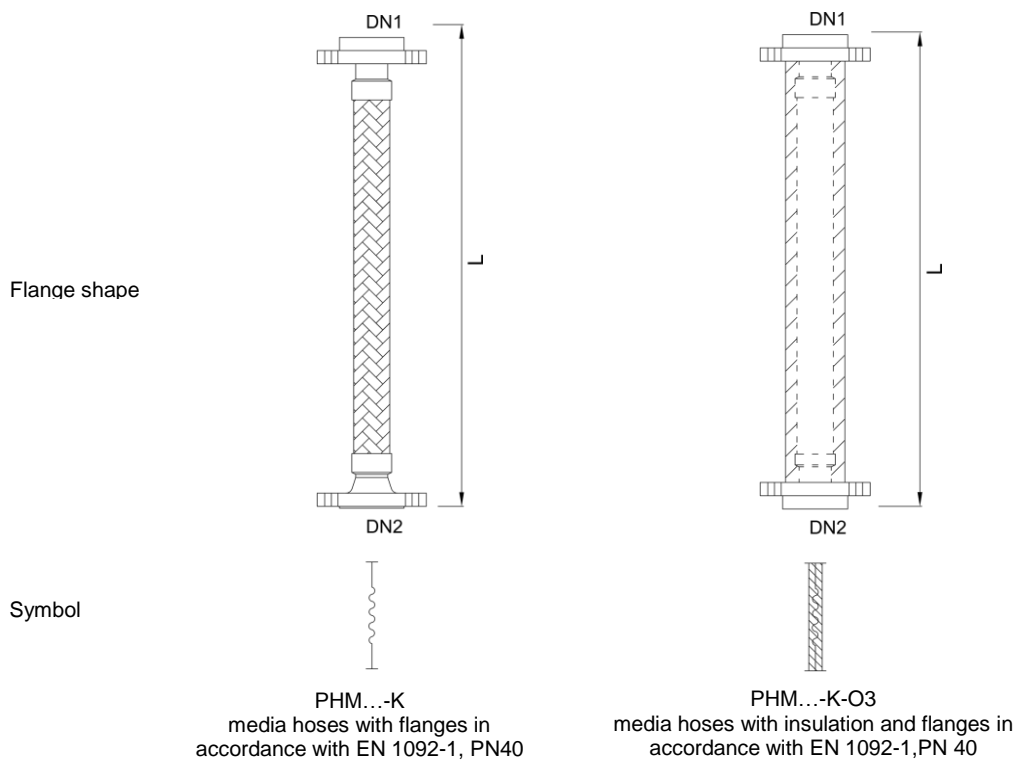

DN	L	n x d	Approved conditions	Item no.	Item no.
-	[mm]	[mm]	[barg // °C]	Media hose	Media hose, insulated
15	500	Ø65, 4 x Ø14	-1/+16 // -50/+200	PHM 15/0500-K	PHM 15/0500-K-O3
15	1000	Ø65, 4 x Ø14	-1/+16 // -50/+200	PHM 15/1000-K	PHM 15/1000-K-O3
15	2000	Ø65, 4 x Ø14	-1/+16 // -50/+200	PHM 15/2000-K	PHM 15/2000-K-O3
25	500	Ø85, 4 x Ø14	-1/+16 // -50/+200	PHM 25/0500-K	PHM 25/0500-K-O3
25	1000	Ø85, 4 x Ø14	-1/+16 // -50/+200	PHM 25/1000-K	PHM 25/1000-K-O3
25	2000	Ø85, 4 x Ø14	-1/+16 // -50/+200	PHM 25/2000-K	PHM 25/2000-K-O3

OPTIONS PIPING AND TUBING

For piping items the following options can be chosen in addition to the standard structural components. The option chosen must be entered at the end of the item number. Several options can be chosen and they are presented as far as possible in alphabetical order. In the following table you will find examples of item numbering for additional options.

Product name:	Item number	Examples
Pipe section with special length, for example 265 mm:	PP DN/length-K	PP 100/0265-K
Pipe section with coating:	PP DN/length-K-C1	PP 100/0150-K-C1
Pipe section with material certificate:	PP DN/length-K-Z2	PP 100/0150-K-Z2
Pipe section with coating and material certificate:	PP DN/length-K-C1-Z2	PP 100/0150-K-C1-Z2

You can choose from the following options:

OPTION C – COATING / GLASS TYPE

The standard components are those made of borosilicate glass 3.3 without coating. Various transparent coatings can be chosen as optional extras. Please refer to the specification on coatings in chapter 10 »technical information«.

C1 = coating, non-conductive

C2 = coating, non-conductive, for high temperatures and chemical resistance

C3 = coating, conductive

C4 = amber glass based on borosilicate glass 3.3

C5 = quartz glass¹⁾

1) Deliverable up to DN 300 with a limited product programme

OPTION F – FLANGE TYPE

The standard component is made of borosilicate glass 3.3 with the flange type according to the article code

The standard flanges (see page 1.2) are

F1 = KF flanges, KF../1 type

F2 = KF flanges, type KF../2

F3 = KF flanges, type KF../3

F4 = PF flanges, PF type

All other combinations of the flange types F1 to F4 can be added as optional extras.

OPTION L – SPECIAL LENGTHS

Special lengths of piping can be delivered. Please enter the length you would like directly in the item number of the piping.

Special lengths of tubing can also be delivered. Please enter your preferred length according to the list of options and we will check if this is possible.

L □□□□ = special length L in mm, e.g. L0235 for 235 mm length

OPTION M – MATERIAL / PTFE-DESIGN

White virgin non-conductive PTFE material is used for components made of PTFE or for constructions containing PTFE which come into contact with products.

The following alternatives can also be delivered:

M1 = PTFE conductive

M2 = PTFE conductive with earthing

OPTION O – SPECIAL OPTIONS

The following special options are offered for certain structural components.

O1 = pipe sections type PP with continuous minimal inner diameter according nominal bore for structured packings

O2 = pipe sections type PP with calibrated inner diameter

O3 = insulation (only for temperature tubes)

OPTION Z – CERTIFICATES

Standard deliveries do not come with certificates.

The following certificates can optionally be delivered with your order.

Z1 = FDA material certificate¹⁾

Z2 = material certificate 2.2

Z3 = Certificate for Technical Guidelines on Air Quality Control (TA-Luft)

1) FDA material certificates can be delivered for product-side structural components containing PTFE.